

KENWOOD

INTEGRATED AMPLIFIER

KA-892

INSTRUCTION MANUAL

KENWOOD CORPORATION

B60-0993-00 (JA) (K) (WS)

Introduction

Your choice of this product indicates that you are a devotee to excellence in sound reproduction. We appreciate your patronage and take pride in the long tradition of quality components that our company represents. So that you can get the most out of your unit, we suggest that you take the time to read through this manual before you hook up and operate your system. This will acquaint you with operating features and system-connection considerations so that your listening pleasure will be enhanced right from the start. You will notice that in all aspects of planning, engineering, styling, operating convenience and adaptability we have sought to anticipate your needs and desires.

Keep this manual handy for future reference.

For your records

Record the serial number, found on the back of the unit, in the spaces designated on the warranty card, and in the space provided below. Refer to the model and serial numbers whenever you call upon your dealer for information or service on this product.

Model _____ Serial Number _____

Unpacking

Unpack the unit carefully and make sure that all accessories are put aside so they will not be lost. Examine the unit for any possibility of shipping damage. If your unit is damaged or fails to operate, notify your dealer immediately. If your unit was shipped to you directly, notify the shipping company without delay. Only the consignee (the person or company receiving the unit) can file a claim against the carrier for shipping damage. We recommend that you retain the original carton and packing materials for use should you transport or ship the unit in the future.

Accessories

- AC plug adaptor 1
(Except for some areas)
For the unit with a Euro-pean AC plug in areas other than Europe.
- System control cord 1
(Except for some areas)







RC-992

- Remote control unit 1
- Batteries (R6/AA) 2



Contents

Caution: Read the pages marked  carefully to ensure safe operation.

Introduction	2	Graphic equalizer operation	14
 Before applying power	3	Operation for components connected to the TAPE 2/ADAPTOR jacks	17
 Safety precautions	3	Remote control operation (RC-992)	18
 IMPORTANT SAFEGUARDS	4	Remote control operation (RC-190)	19
System connections	6	In case of difficulty	24
System control operation	8	 Specifications (For U.S.A. and Canada)	25
Controls and indicators	10	 Specifications (For other countries)	26
Operating instructions	11		

Before applying power

Caution: Read this page carefully to ensure safe operation.

For the U.S.A. and Canada

Important!

Units shipped to the U.S.A. and Canada are designed for operation on 120 volts AC only.

CAUTION: TO PREVENT ELECTRIC SHOCK DO NOT USE THE AC PLUG WITH AN EXTENSION CORD, RECEPTACLE OR OTHER OUTLET UNLESS THE BLADES CAN BE FULLY INSERTED TO PREVENT BLADE EXPOSURE.

For the United Kingdom

Important!

Units shipped to the U.K. are designed for operation on 240 volts AC only.

The mains plug must be removed from the wall socket prior to any internal examination.

The wires in this mains lead are coloured in accordance with the following code:

Blue Neutral
Brown Live

The wires in this mains lead must be connected to the terminals in the plug as follows:

Wire colour **Plug terminal marking**
Blue N or Black
Brown L or Red

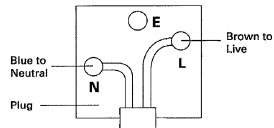

- Notes:**
1. If a 13-amp plug is used, this must be fitted with a 5-amp fuse.
 2. If a 3-pin plug with earthing contact is used, no wire must be connected to the E terminal.

For Australia and Europe

Important!

Units shipped to Australia are designed for operation on 240 VAC only.

Units shipped to Europe are designed for operation on 230 V AC only.

For other countries

Important!

Units shipped to countries other than the above countries are equipped with an AC voltage selector switch on the rear panel. Refer to the following paragraph for the proper setting of this switch.

AC voltage selection

This unit operates on 110 - 120 or 220 - 240 volts AC. The AC voltage selector switch Type A or Type B on the rear panel is set to the voltage that prevails in the area to which the unit is shipped. Before connecting the power cord to your AC outlet, make sure that the setting position of this switch matches your line voltage. If not, it must be set to your voltage in accordance with the following direction.

Note:

Our warranty does not cover damage caused by excessive line voltage due to improper setting of the AC voltage selector switch.

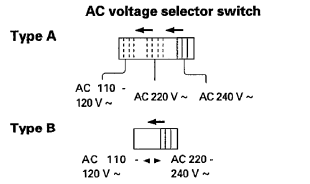

Move switch lever to match your line voltage with a small screwdriver or other pointed tool.

Safety precautions

WARNING: TO PREVENT FIRE OR ELECTRIC SHOCK, DO NOT EXPOSE THIS APPLIANCE TO RAIN OR MOISTURE.

<p>CAUTION RISK OF ELECTRIC SHOCK DO NOT OPEN</p>	<p>CAUTION: TO REDUCE THE RISK OF ELECTRIC SHOCK, DO NOT REMOVE COVER (OR BACK). NO USER-SERVICEABLE PARTS INSIDE, REFER SERVICING TO QUALIFIED SERVICE PERSONNEL.</p>
	<p>THE LIGHTNING FLASH WITH ARROWHEAD SYMBOL, WITHIN AN EQUILATERAL TRIANGLE, IS INTENDED TO ALERT THE USER TO THE PRESENCE OF UNINSULATED "DANGEROUS VOLTAGE" WITHIN THE PRODUCT'S ENCLOSURE THAT MAY BE OF SUFFICIENT MAGNITUDE TO CONSTITUTE A RISK OF ELECTRIC SHOCK TO PERSONS.</p>
	<p>THE EXCLAMATION POINT WITHIN AN EQUILATERAL TRIANGLE IS INTENDED TO ALERT THE USER TO THE PRESENCE OF IMPORTANT OPERATING AND MAINTENANCE (SERVICING) INSTRUCTIONS IN THE LITERATURE ACCOMPANYING THE APPLIANCE.</p>

IMPORTANT SAFEGUARDS

 Caution: Read this page carefully to ensure safe operation.

Please read all of the safety and operating instructions before operating this unit. For best results, follow all warnings placed on the unit and adhere to the operating and use instructions. These safety and operating instructions should be retained for future reference.

- 1. Power sources** – The unit should be connected to a power supply only of the type described in the operating instructions or as marked on the appliance.
- 2. Power-cord protection** – Power-supply cords should be routed so that they are not likely to be walked on or pinched by items placed upon or against them, pay particular attention to cords at plugs, convenience receptacles, and the point where they exit from the unit.

Never pull or stretch the cord.



- 3. Grounding or polarization** – The precautions should be taken so that the grounding or polarization means of this unit is not defeated.
- 4. Ventilation** – The unit should be situated so that its location or position does not interfere with its proper ventilation.
To maintain good ventilation, do not put records or a table-cloth on the unit. Place the unit at least 10 cm away from the walls.
Do not use the unit on a bed, sofa, rug or similar surface that may block the ventilation openings.

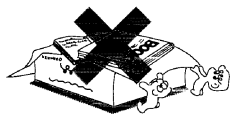

- 5. Water and moisture** – The unit should not be used near water - for example, near a bathtub, washbowl, kitchen sink, laundry tub, in a wet basement, or near a swimming pool, etc.

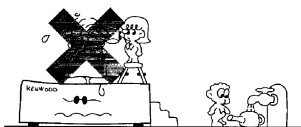

- 6. Temperature** – The unit may not function properly if used at extremely low, or freezing temperatures. The ideal ambient temperature is above +5°C (41°F).

- 7. Heat** – The unit should be situated away from heat sources such as radiators, heat registers, stoves, or other units (including amplifiers) that produce heat.



- 8. Electric shock** – Care should be taken so that objects do not fall and liquid is not spilled into the enclosure through openings. If a metal object, such as a hair pin or a needle, comes into contact with the inside of this unit, a dangerous electric shock may result. For families with children, never permit children to put anything, especially metal, inside this unit.

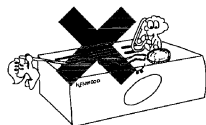

- 9. Enclosure removal** – Never remove the enclosure. If the internal parts are touched accidentally, a serious electric shock might occur.

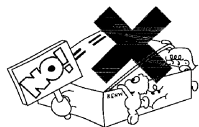

- 10. Magnetic fields** – Keep the unit away from sources of magnetic fields such as TV sets, speaker systems, radios, motorized toys or magnetized objects.

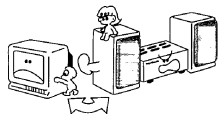

- 11. Cleaning** – Do not use volatile solvents such as alcohol, paint thinner, gasoline, or benzene, etc. to clean the cabinet. Use a clean dry cloth.



Introduction

Your choice of this product indicates that you are a devotee to excellence in sound reproduction. We appreciate your patronage and take pride in the long tradition of quality components that our company represents. So that you can get the most out of your unit, we suggest that you take the time to read through this manual before you hook up and operate your system. This will acquaint you with operating features and system-connection considerations so that

Accessories

- AC plug adaptor 1
(Except for some areas)
For the unit with a Euro-pean AC plug in areas other than Europe.
- System control cord 1
(Except for some areas)

12. Carts and stands – An appliance and cart combination should be moved with care. Quick stops, excessive force, and uneven surfaces may cause the appliance and cart combination to overturn.



13. Nonuse periods – The power cord of the unit should be unplugged from the outlet when left unused for a long period of time.

14. Abnormal smell – If an abnormal smell or smoke is detected, immediately turn the power OFF and pull out the power cord. Contact your dealer or nearest service center.

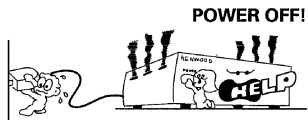

15. Damage requiring service – The unit should be serviced by qualified service personnel when:

- A.** The power-supply cord or the plug has been damaged; or
- B.** Objects have fallen, or liquid has been spilled into the unit; or
- C.** The unit has been exposed to rain; or
- D.** The unit does not appear to operate normally or exhibits a marked change in performance; or
- E.** The unit has been dropped, or the enclosure damaged.

16. Servicing – The user should not attempt to service the unit beyond that described in the operating instructions. All other servicing should be referred to qualified service personnel.

17. Outdoor antenna grounding – If an outside antenna is connected to the receiver, be sure the antenna system is grounded so as to provide some protection against voltage surges and built up static charges. Section 810 of the National Electrical Code, ANSI/NFPA 70, provides information with respect to proper grounding of the mast and supporting structure, grounding of the lead-in wire to an antenna discharge unit, size of grounding conductors, location of antenna-discharge unit, connection to grounding electrodes, and requirements for the grounding electrode. See Figure.

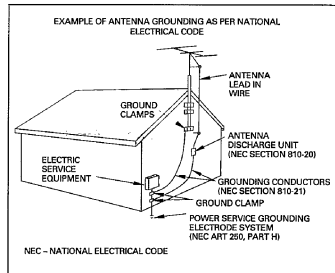

18. Power lines – An outdoor antenna should be located away from power lines.

19. AC outlets – Do not connect other audio equipment with a power consumption larger than that specified to the AC outlet on the rear panel. Never connect other electrical units, such as an iron or toaster, to it to prevent fire or electric shock.

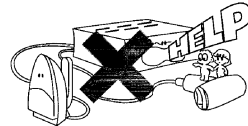

Notes:

1. Item 3 is not required except for grounded or polarized equipment.
2. Item 17 and 18 are not required except for units provided with antenna terminals.
3. Item 17 complies with UL in the U.S.A.

System connections

Make connections as shown below. When connecting the related system components, refer also to the instruction manuals of the related components.
Do not plug in the power lead until all connections are completed.

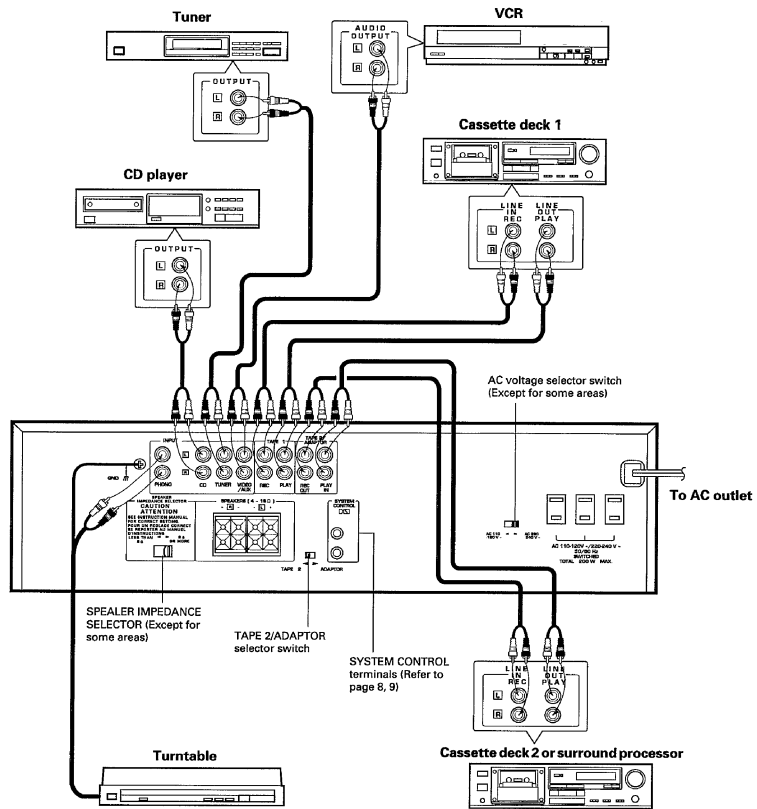

Notes:

1. Connect all cords firmly. If connections are loose, there could be loss of sound or noise produced.
2. When plugging and unplugging connection cords, be sure to first remove the power cord from the AC outlet. Plugging/unplugging connection cords without removal of the power cord can cause malfunctions or damage to the unit.
3. Do not connect up a power source which is larger than that indicated on the socket at the rear of the unit.

■ Connection of speakers

① Push lever down.



② Insert cord.



③ Lock lever.



- Never short-circuit the + and - speaker cords.
- If the left and right speakers are connected inversely or if the speaker cords are connected with reversed polarity, the sound becomes unnatural with ambiguous acoustic image positioning. Be sure to connect the speakers and speaker cords correctly.

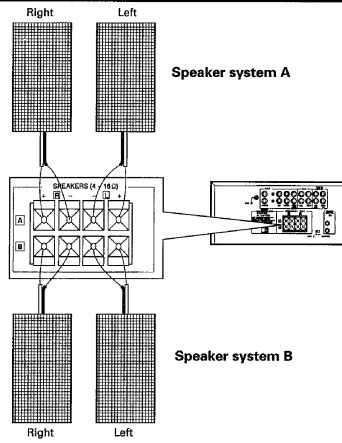

■ Setting the SPEAKER IMPEDANCE SELECTOR (Except for some areas)

Speaker impedance	Selector position
4Ω, 6Ω	"LESS THAN 8Ω"
8Ω, 16Ω	"8Ω OR MORE"



According to the impedance of the speakers used, set the SPEAKER IMPEDANCE SELECTOR on the rear panel as shown in the table.

- During speaker system connection and operation of the SPEAKER IMPEDANCE SELECTOR, set the POWER key to OFF.
- When only one set of speakers is used, use the SPEAKERS A terminals.
- Even when only one of speaker systems A and B uses 4Ω or 6Ω speakers, be sure to set the SPEAKER IMPEDANCE SELECTOR to "LESS THAN 8Ω".

Speaker protection circuit

If "-----" appears on the display window, immediately turn power off by pressing the POWER key (keys other than the POWER key are not accepted). The positive (+) and negative (-) speaker cords may possibly be short-circuited. If they are short-circuited, connect the cords properly and turn power on again.

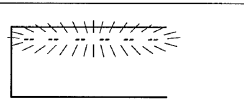

System control operation

For the system control of KENWOOD system components, connect them using the system control cords as shown in the illustration below.
 If the power cords are connected as shown in the illustration, the power of the whole system can be switched ON/OFF from the POWER key on the amplifier.
 (For the audio cord connection, please refer to "System connections".)

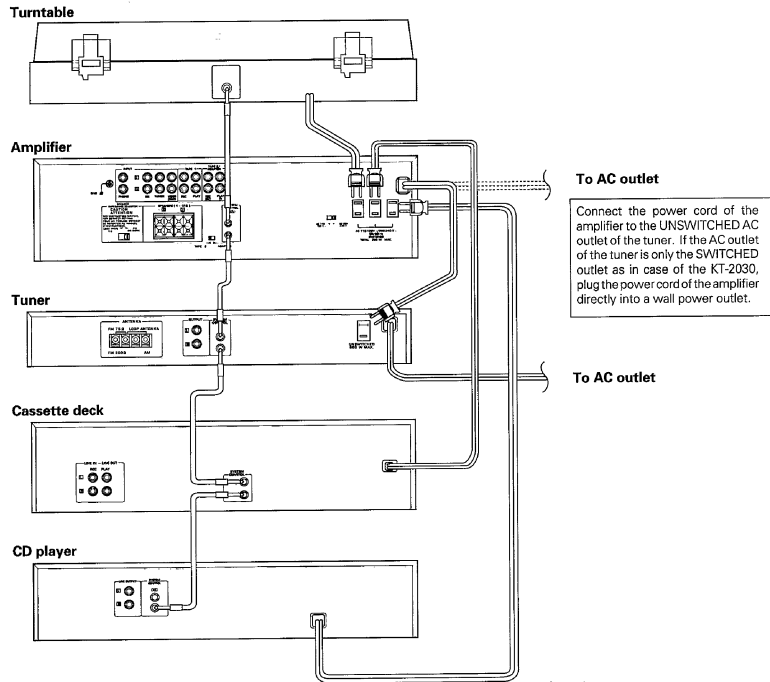

AC outlet

Unit destination	Shape of the AC outlet
U.S.A., Canada and U.S. Military	
Australia	
Other countries	

SWITCHED AC outlet

The power of the component connected to this kind of AC outlet is switched ON/OFF in interlocked operation with the POWER key on the main unit on which the AC outlet is installed.

Notes:

- Do not connect the system control cord to the cassette deck connected to the TAPE 2/ADAPTOR jacks.
- For system connection of Australia-model components, connect the power cord of the turntable directly to a wall mains outlet.

SYSTEM CONTROL Operation

By connecting this unit to other KENWOOD system components equipped with SYSTEM CONTROL terminals, such as a tuner, tape deck, CD player and/or turntable, the following convenient operations will be available.

Automatic play operation

When starting play with the turntable, tape deck, or CD player connected to this unit, set the INPUT SELECTOR knob to PHONO, TAPE or CD. The turntable, tape deck, or CD player will automatically enter play mode.

In the same way, pressing the Play key of the turntable, tape deck, or CD player will automatically switch the INPUT SELECTOR setting on this unit to the component on which the Play key is pressed.

Synchro recording

To record the sound from the CD player or turntable onto a tape with the tape deck, set the INPUT SELECTOR knob to CD or PHONO and load a CD or record. Set the tape deck to record-pause mode, then press the Play (START) key of the CD player or turntable. The deck will start recording automatically, synchronized with the CD player or turntable starting playing. For more details, refer to the instruction manual of the tape deck.

Remote control

When the amplifier, tuner, tape deck, CD player, turntable and surround processor (SS-992, SS-592) are connected via the system control cords, these components can be controlled from the remote control unit supplied with this unit.

System control connection

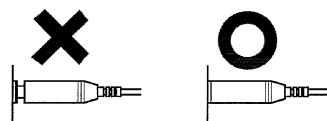

- Be sure to insert the system control cord plugs fully into the SYSTEM CONTROL terminals.
- If the system control cord and audio cords are not connected properly, the automatic system governing remote control and system functions will not operate.

Notes:

1. System control operation of the cassette deck connected to the TAPE 2/ADAPTOR jacks cannot be carried out.
2. If the components connected to this unit are not KENWOOD system components, do not connect anything to the SYSTEM CONTROL terminals.

Controls and indicators

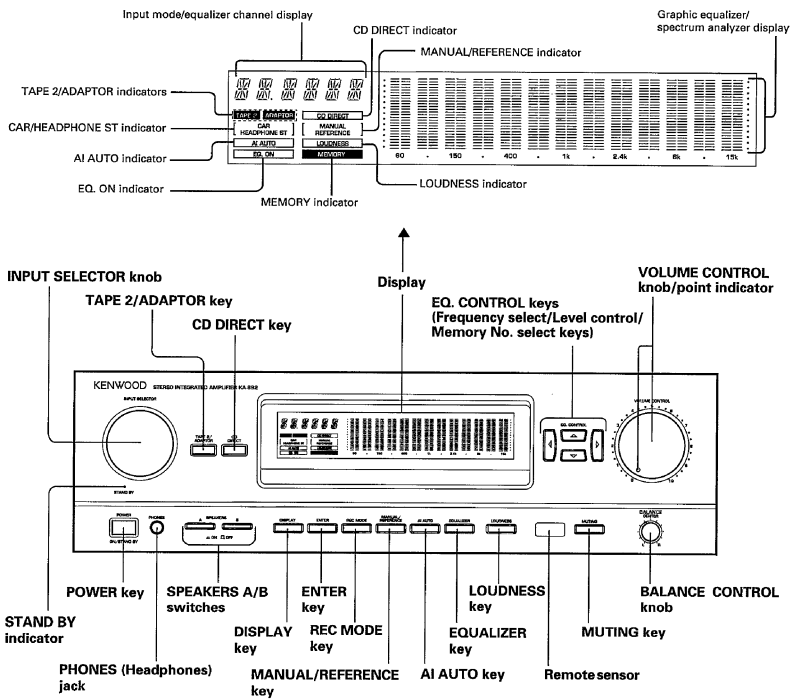

SPEAKERS A and B switches

- A,B OFF:** This position silences all speakers to permit private use of headphones.
- A ON:** Activates speakers connected to the SPEAKERS A terminals on the rear panel.
- B ON:** Activates the speakers connected to the SPEAKERS B terminals on the rear panel.
- A,B ON:** Activates the speakers connected to the SPEAKERS A and B terminals simultaneously.

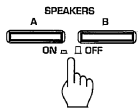

- When speakers are connected only to the SPEAKERS A terminals, the sound will not be heard if both the SPEAKERS A and B switches are depressed to the ON position.

STAND BY mode of POWER key

When the power cord of this system is plugged into an AC outlet, the STAND BY indicator lights up regardless of the ON/OFF setting of the POWER switch. This indicates that a small amount of current is being supplied to the unit to back up the memory contents. This mode is referred to as the Stand By mode. While the STAND BY indicator is lit, the power of the system can be switched ON/OFF from the remote control unit.

Operating instructions

Basic operation

1 Turn the power on.



2 Select the input source.

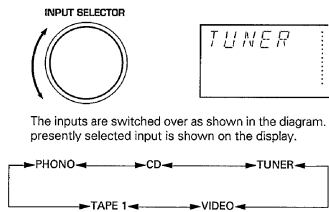

The inputs are switched over as shown in the diagram. The presently selected input is shown on the display.

- Do not set the INPUT SELECTOR knob in the mid position between click positions.

3 Play the source component.

- The selected source component is played automatically if it is connected using a system control cord.

4 Adjust the volume.

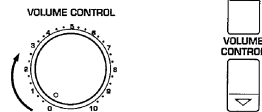

5 Adjust the left and right volume balance.

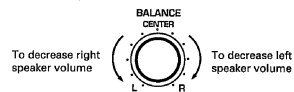

- For the tone control, refer to "Graphic equalizer operation" on page 14.

To mute the sound temporarily

Press the MUTING key.

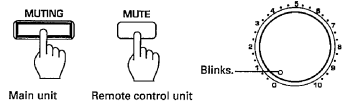

- Pressing the key again resumes the previous volume.

Listening through headphones

1 Insert the headphone plug into the headphones jack.



- Set the SPEAKERS switches so that both speaker systems A and B are OFF.

2 Adjust the volume.

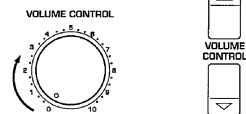

Note:

When the TAPE 2/ADAPTOR selector on the rear panel is set to the TAPE 2 position and the TAPE 2/ADAPTOR key is set to ON, the source selected with the INPUT SELECTOR knob cannot be heard from the speakers. To listen to a source other than cassette deck 2, be sure to set the TAPE 2/ADAPTOR key to OFF.

Function of the LOUDNESS key

While dynamic sound can be experienced at high volume levels, music may become flat with poor bass and treble when the volume is set low. To compensate absence of bass and treble sound, press the LOUDNESS key.

When the LOUDNESS key is pressed, the built-in equalizer is automatically turned on and the sound compensated with the displayed equalizer setting is reproduced with loudness effect.

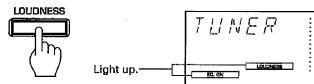

- When the LOUDNESS key is pressed again, the LOUDNESS indicator goes off and the loudness function is set to OFF. However, the equalizer setting is not cleared.
- The sound compensated with loudness effect can be recorded on cassette deck 1.
- The loudness function can be carried out only when the LOUDNESS indicator and EQ. ON indicator are lit.

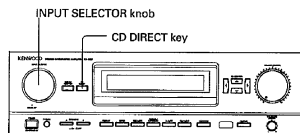

■ Operation of CD DIRECT playback

The digital sound of Compact Disc features an ideal reproduction-characteristics, and the sound quality provided by CD can be reproduced with least degradation by means of the CD direct playback function.

1 Press the CD DIRECT key.

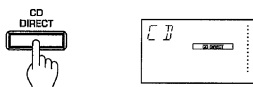

2 Play the CD player.

- The CD DIRECT selection is given priority to any other source being selected by the INPUT SELECTOR knob.

To cancel the CD DIRECT playback function

Press the key again.



Select a music source other than CD.

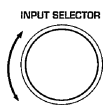

Notes:

1. During CD DIRECT playback, the graphic equalizer does not function.
2. When the TAPE 2/ADAPTOR selector on the rear panel is set to the ADAPTOR position and the ADAPTOR indicator on the display is lit, the CD DIRECT playback function cannot be carried out.

■ Listening to CD while recording another source

1 Select the source to be recorded.

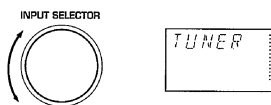

2 Set cassette deck 1 to record-pause mode and play the source to be recorded.

3 Start recording on the cassette deck connected to the TAPE 1 jacks.

- When the [EQUALIZER] key is pressed, the sound can be recorded together with the equalizer effect.

4 Press the CD DIRECT key.

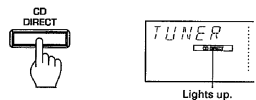

5 Play the CD player.

- The source name on the display remains the same, i.e. the name of the recorded source.
- The total level of the source being played and source being recorded is displayed with spectrum analyzer.

When the cassette deck is connected to the TAPE 2 / ADAPTOR jacks, be sure to set the TAPE 2 / ADAPTOR selector to the TAPE 2 position.

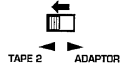

Set this selector only when the power is turned off.

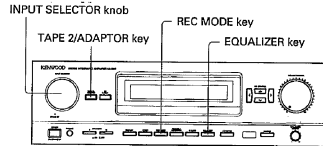

■ Ordinary tape recording

1 Select the source to be recorded.

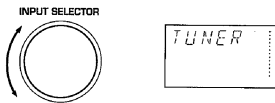

2 Set cassette deck 1 or 2 in the record-pause mode.

- When the [EQUALIZER] key is pressed, the sound can be recorded together with the equalizer effect.

3 Play the source component to be recorded and start recording it on the cassette deck.

- In case of tape dubbing (TAPE 1 → TAPE 2), play the cassette deck connected to TAPE 1 and record on the cassette deck connected to TAPE 2.

Note:
The input to this unit cannot be changed over while the cassette deck connected to this unit via the system control cord is in the record mode. When it is required to change the input source, put the cassette deck in the stop mode beforehand.

■ Tape dubbing (TAPE 2 → TAPE 1)

1 Press the TAPE 2/ADAPTOR key.

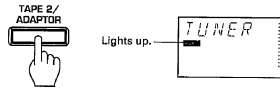

2 Select a source other than TAPE 1.

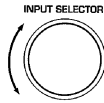

3 Play cassette deck 2 and start recording on cassette deck 1.

- Do not select TAPE 1 while dubbing.
- When the [EQUALIZER] key is pressed, the sound can be recorded together with the equalizer effect.

■ Recording sound with equalizer effect applied (TAPE 1 only)

To compensate the sound for general home use

1 Press the EQUALIZER key.

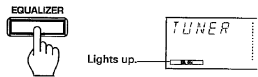

2 Select a desired equalizer pattern.

- Select a desired equalizer pattern from among the MANUAL and REFERENCE preset equalizer patterns. See page 14, 15.
- You can also create an equalizer pattern of your own. See page 16.

3 Start recording.

To compensate the sound for use in a car or with stereo headphones.

1 Press the EQUALIZER key.

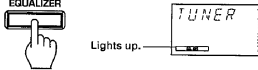

2 Select a desired equalizer pattern.

- Select a desired equalizer pattern from among the MANUAL and REFERENCE preset equalizer patterns. See page 14, 15.
- You can also create an equalizer pattern of your own. See page 16.

3 Select CAR or HEADPHONE ST according to your purpose.

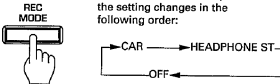

Each time this button is pressed the setting changes in the following order:

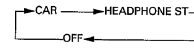

4 Start recording.

Graphic equalizer operation

10 types of equalizer patterns (R1 - R5, M1 - M5) are preset in memory, allowing you to enjoy the sound according to the genre of music. The 5 equalizer patterns in MANUAL mode can be modified as you prefer. In addition, this unit incorporates an AI equalizer function which automatically selects an equalizer pattern corresponding to the music being played.

■ Applying a preset equalizer effect

1 Press the EQUALIZER key so that the EQ. ON indicator lights.



Main unit



Remote control unit

2 Select a desired equalizer pattern.

① Select MANUAL mode or REFERENCE mode.



② Select the equalizer pattern with the EQ. CONTROL ▲ or ▼ key.

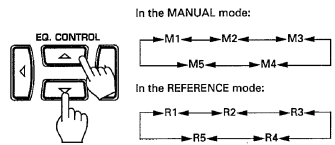

When using the remote control unit, select the equalizer pattern with the M. CALL key.



Each time the key is pressed, the equalizer pattern changes in the following order:

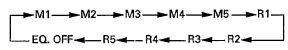

■ Applying a sound effect with the AI equalizer

Press the AI AUTO key.

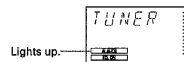

Lights up.

- The unit automatically detects the proper equalizer pattern corresponding to the music being played after sampling the sound for about 20 seconds.
- When the sound level is low or muted, the unit cannot detect the equalizer pattern properly.

To cancel the AI equalizer function

Press the AI AUTO key again.

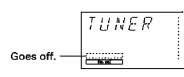

Goes off.

- The equalizer curve becomes flat.

To cancel the equalizer effect

Press the EQUALIZER key again.

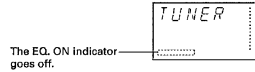

The EQ. ON indicator goes off.

■ Table of preset equalizer patterns

R1 - R5 in the REFERENCE mode	M1 - M5 in the MANUAL mode These preset memories (M1 - M5) are also used to store the equalizer settings you make.
R1 Soft: Reproduces a soft sound appropriate for background music.	M1 Classic clear: Effective for playing classic orchestra music with boosted mid-high frequencies.
R2 Clear: Reproduces a clear and bright sound by attenuating the level of low frequencies.	M2 Classic heavy: Boosts low frequencies. When a rich bass sound is desired for playing classic orchestra music, use this pattern.
R3 Heavy: Effective for playing rock music or jazz fusion music to reproduce a dynamic sound.	M3 Classic scale: Obtains wide acoustics when playing the classic orchestra music.
R4 Scale: Provides wide and dynamic acoustics.	M4 Classic old: Attenuates high frequency noise. Effective for playing sources with noticeable noise such as classic orchestra music recorded many years ago, reproducing agreeable sound.
R5 Movie scale: Reproduces a "live" atmosphere and dynamic sound when playing the sound of movies which contain excessive high and low frequencies.	M5 Movie normal: Reproduces a "live" atmosphere and dynamic sound when playing the sound of movies.

Display function



Each time the [DISPLAY] key is pressed, the display mode changes in the following order: demonstration mode → spectrum analyzer mode → graphic equalizer mode → demonstration mode.

Demonstration display mode

Sequentially displays various functions of this unit, such as equalizer patterns, display modes, etc.
 ● To exit demonstration mode, select another display mode by pressing the [DISPLAY] key.

Spectrum analyzer display mode

Displays the frequency distribution of the source being played for understanding at a glance.

Graphic equalizer display mode

Displays how each frequency range is compensated.

Demonstration display mode

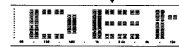

Spectrum analyzer display mode

Normal

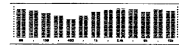

Shower

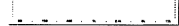

Horizontal

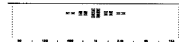

Graphic equalizer display mode



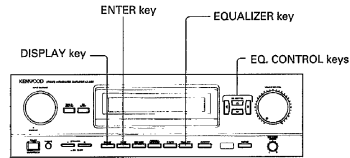

■ Creating an equalizer pattern

You can create a desired equalizer pattern by operating the equalizer control keys. Observe the graphic equalizer display and listen to the sound compensated with equalizer effect.

1 Display the graphic equalizer curve.

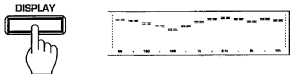

- Press the **DISPLAY** key so that the equalizer display appears in the display window.

2 Press the EQUALIZER key.

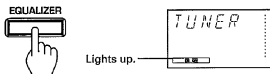

- The previous equalizer setting appears in the display window.

3 Select the frequency band to be adjusted.

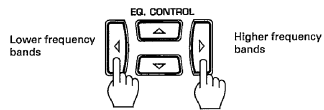

4 Adjust the level of the selected frequency band.

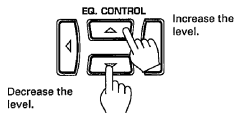

5 Repeat steps 3 and 4 for other frequency bands, if necessary.

■ Storing a user-created pattern

Up to 5 equalizer patterns created by you can be stored in memory.

1 Create a desired equalizer pattern.

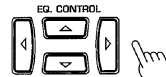

- Refer to "Creating an equalizer pattern".

2 Press the ENTER key.



- The MEMORY indicator blinks.

3 Select the memory number in which the equalizer pattern is to be stored.

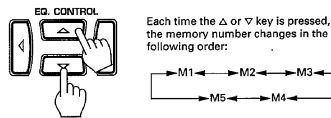

Each time the Δ or ∇ key is pressed, the memory number changes in the following order:

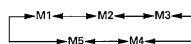

4 Press the ENTER key again.



- The storing operation is completed.
- Be sure to press the ENTER key within 5 seconds after the memory number is selected.

To return to the preset equalizer patterns (MANUAL M1 - M5)

① Press the ENTER key once.



- The memory indicator in the display window blinks.
- ② Press and hold the ENTER key for 5 seconds or more.

Operation for components connected to the TAPE 2/ADAPTOR jacks

Before operating a component connected to the TAPE 2/ADAPTOR jacks, be sure to set the TAPE 2 /ADAPTOR selector on the rear panel.



Set this selector only when the power is turned off.

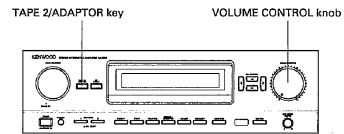

■ Using the surround processor SS-992 or SS-592

By connecting the SS-992 or SS-592 with a system control cord, the remote control unit supplied with this unit can control it.

1 Press the TAPE 2/ADAPTOR key so that the ADAPTOR indicator lights.

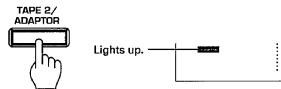

- The VOLUME CONTROL knob is automatically set to the center position in about 20 seconds.

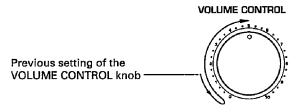

2 Adjust the level of the surround sound.

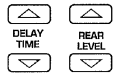

Remote control unit

- For details, refer to the instruction manual supplied with the surround processor.

3 Adjust the entire volume level.

The entire volume level can be adjusted with the volume control of the surround processor or the VOLUME CONTROL keys on the remote control unit.

When the surround processor is not used

Press the TAPE 2/ADAPTOR key again.

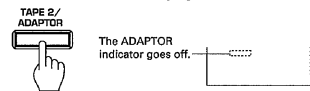

- The VOLUME CONTROL knob of this unit is automatically set to the minimum position in about 20 seconds.

Notes:

- When using a component other than the SS-992 or SS-592, be sure to set the TAPE 2/ADAPTOR selector on the rear panel to the TAPE 2 position.
- When the TAPE 2/ADAPTOR key is turned on, the synchronized recording cannot be carried out.

■ Using a component other than the surround processor SS-992 or SS-592

When the TAPE 2/ADAPTOR key is set to the TAPE 2 position, the component connected to the TAPE 2/ADAPTOR jacks will be played regardless of the setting of the INPUT SELECTOR knob. It is advisable to connect a cassette deck.

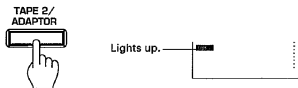

- When the component connected to the TAPE 2/ADAPTOR jacks is not being used, press the TAPE 2/ADAPTOR key so that the TAPE 2 indicator goes off.
- With the TAPE 2 setting, the component connected to the TAPE 2/ADAPTOR jacks cannot be controlled with the remote control unit supplied with this unit.

Note:

When a cassette deck is connected to the TAPE 2/ADAPTOR jacks, be sure to set the TAPE 2/ADAPTOR selector on the rear panel to the TAPE 2 position. If the TAPE 2/ADAPTOR selector is set to the ADAPTOR position, pressing the TAPE 2/ADAPTOR key increases the volume level to the high position automatically and speakers may be damaged.

Remote control operation (RC-190)

The optional remote control unit (RC-190) can not only be used as the system remote control unit of KENWOOD system components, but also as a "learning" remote control which allows to program the remote control signals of other components and operate various components from a single remote control unit.

- The remote control keys can be used in three ways according to the setting of the MODE switch. The majority of the key functions in the AUDIO mode and some of those in the VIDEO mode are the original codes preset at the factory for use in operating KENWOOD components.

Remote control operation (RC-992)

Cassette tape deck operation keys

The TAPE A and TAPE B keys allow to operate a double cassette tape deck. When using a single cassette tape deck, use the TAPE B keys.

Graphic equalizer operation keys

ON/OFF: Turns the graphic equalizer effect ON/OFF.
M. CALL: Recalls equalizer patterns stored in memory.
AI AUTO: Turns the AI equalizer ON/OFF.

Input selector keys

Switch the input selector on the amplifier.

MUTE key

Press to mute the volume temporarily.

POWER key

Press to turn on and off the power.

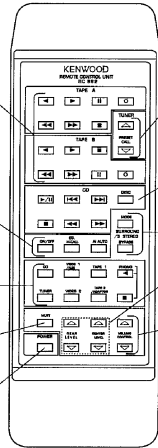

TUNER operation keys

Select the preset stations.

CD player operation keys

Operate the CD player.

DISC: The DISC key can be used as the disc selector key of a multi-disc player with a disc changer. For details, read the instruction manual provided with the CD player.

Surround processor operation keys

Operate the surround processor SS-992 or SS-592.

VOLUME CONTROL keys

Adjust the volume level of this unit and the sound processor SS-992 or SS-592.

■ Loading batteries

1 Remove the cover.

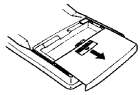

2 Insert batteries.

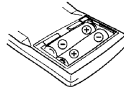

- Insert two AA-size (R6/SUM3) batteries as indicated by the polarity marking.

3 Close the cover.

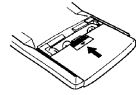

■ Operating procedure

Plug the power cord of the system into an AC wall outlet, and press the **POWER** key on the remote control unit to turn the power on.

When the power is turned on, press the key of the source component to be operated.

- When two operation keys on the remote control unit are pressed successively, press each key securely reserving an interval of more than 1 second for each press.
- Components connected via the system control cords can also be remote-controlled. In this case, please read the instruction manual supplied with your component.

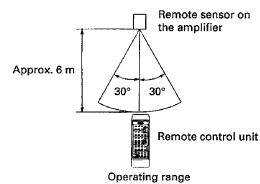

Notes:

1. The supplied batteries are intended for use in operation checks. Therefore, their lives may be shorter than ordinary batteries.
2. When the remote-controllable distance gets shorter than before, replace both batteries with new ones.
3. Malfunction may occur if direct sunlight or the light of a high-frequency lighting fluorescent lamp enters the remote control light sensor. In such a case, change the system installation position to prevent the malfunction.

Graphic equalizer operation

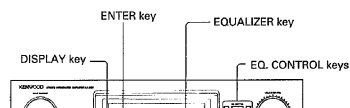

Remote control operation (RC-190)

The optional remote control unit (RC-190) can not only be used as the system remote control unit of KENWOOD system components, but also as a "learning" remote control which allows to program the remote control signals of other components and operate various components from a single remote control unit.

1. The remote control keys can be used in three ways according to the setting of the MODE switch. The majority of the key functions in the AUDIO mode and some of those in the VIDEO mode are the original codes preset at the factory for use in operating KENWOOD components.

AUDIO mode: Can operate KENWOOD system components.

VIDEO mode: Can program remote control signals of other video components to program them.

AUX mode: Can program remote control signals of other A/V components to operate them.

2. Remote control signals can be programmed under space keys in each of the AUDIO, VIDEO and AUX mode.

■ Loading batteries

1 Remove the cover.

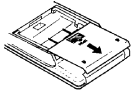

2 Insert batteries.

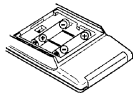

- Insert two batteries as indicated by the polarity marking.

3 Close the cover.



Battery replacement

1. If the TRANSMIT indicator will not light up when an operation key is pressed, the batteries may be exhausted. In this case, replace them with new batteries. It is recommended to use alkaline batteries (LR03) with long life.
2. The programmed contents are not immediately lost when the batteries are removed for replacement. However, they could be lost if the unit is left without batteries for more than 3 minutes. In such a case, the programming should be performed again. The function signals of the non-learning, or fixed keys are not lost even in this case.

■ Operating procedure

Plug the power cord of the system into an AC wall outlet, and press the **POWER** key on the remote control unit to turn the power on.

When the power is turned on, press the key of the source component to be operated.

- When two operation keys on the remote control unit are pressed successively, press each key securely reserving an interval of more than 1 second for each press.
- Components connected via the system control cords can also be remote-controlled. In this case, please read the instruction manual supplied with your component.

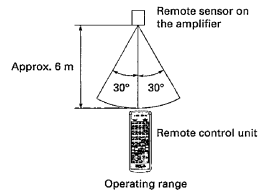

Notes:

1. The supplied batteries are intended for use in operation checks. Therefore, their lives may be shorter than ordinary batteries.
2. When the remote-controllable distance gets shorter than before, replace both batteries with new ones.
3. Malfunction may occur if direct sunlight or the light of a high-frequency lighting fluorescent lamp enters the remote control light sensor. In such a case, change the system installation position to prevent the malfunction.

■ Modes

AUDIO mode

VIDEO mode

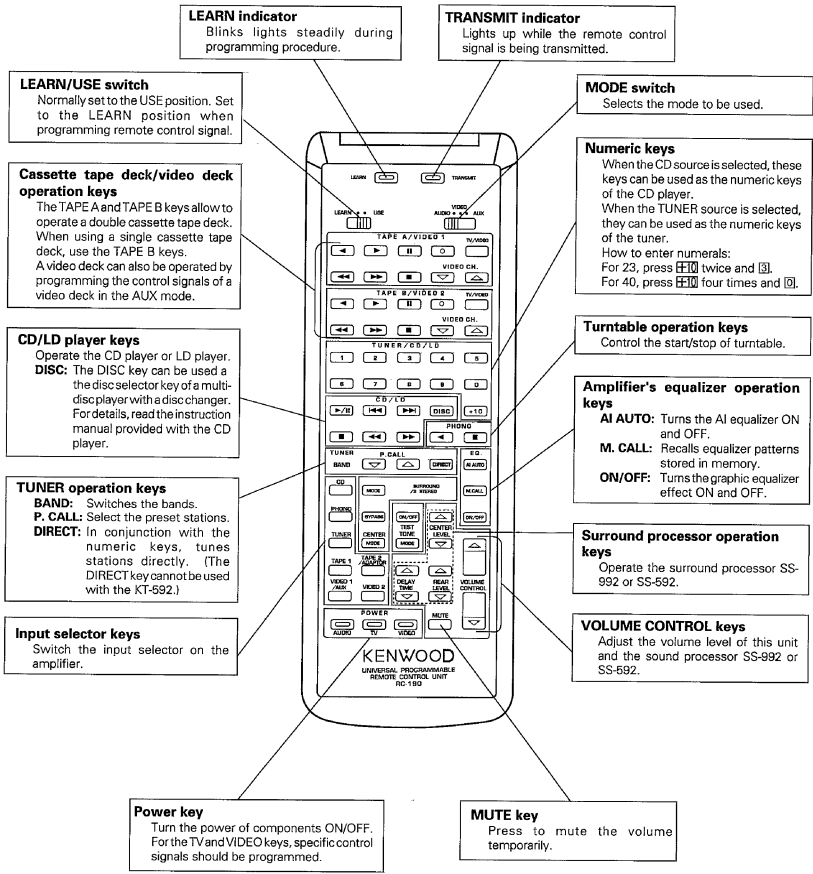

AUX mode

Names of controls (AUDIO mode)

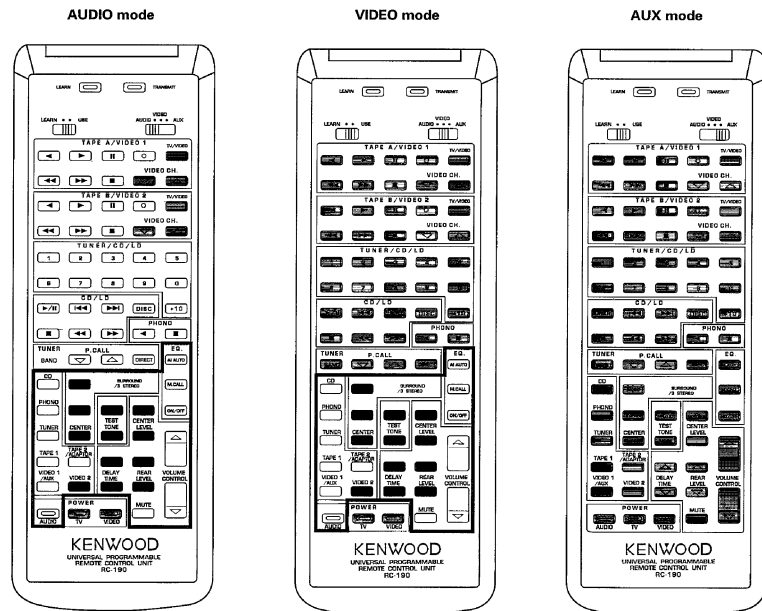

■ Modes



- Keys masked with  are not usable with the basic system (amplifier, tuner, cassette deck and CD player).
- Keys masked with  are space keys which do not contain any signal preset at the factory. Use these keys to program other remote control signals.
- Keys in the area enclosed by thick lines contain same function signals for the AUDIO and VIDEO modes. These keys can be used in the same way in both modes.

Overlay sheet

The provided overlay sheet offers a convenient way to record and remember the contents programmed under the various operation keys.

Write the programmed key contents on the overlay sheet with an oil-based felt-tipped marker or pencil. To erase, use a conventional eraser.

Before use, be sure to peel the covering sheet.

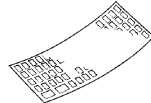

■ Programming operation

Remote control signals of other remote control units can be programmed under space keys on this unit. For space keys, refer to "Modes" on the previous page.

1 Set the LEARN/USE switch to the LEARN position.



2 Set to the desired mode.

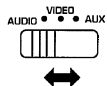

3 Position the remote control units so that their transmitters face each other.

- The distance between the remote control units is about 2 to 5 cm.

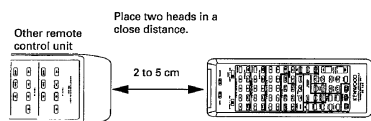

4 To program

① Press one of the keys to be programmed.

- The LEARN indicator lights up.

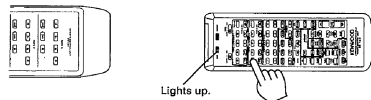

② Hold down the key of the other remote control unit containing the signal to be programmed.

- Programming is complete when the lighted LEARN indicator goes out after blinking twice.
- Hold the key of the other remote control unit depressed until the LEARN indicator goes out.
- To program another remote control signal, repeat steps 2 to 4 again.

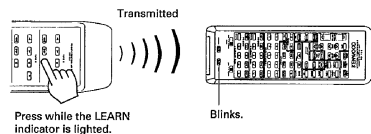

Notes:

- If the optical output level of the other remote control unit is higher, programming may not be carried out correctly. If this occurs, separate this unit and the other remote control unit by a greater distance and perform the programming procedure again.
- If the LEARN and TRANSMIT indicators blink simultaneously during programming, this indicates either that the key being programmed cannot be programmed or that programming has not been performed completely. If this occurs, perform the programming procedure again.
- Remote control functions using signals other than infrared signals or specially-coded signals cannot be programmed. Programming is also impossible when this unit's memory capacity becomes full.
- The LEARN indicator goes out 30 seconds after a programmable key is pressed. After this, programming is impossible. To continue programming, press the programming key again.
- When two or more programmable keys are pressed at the same time, the key which was pressed last will be programmed.
- Do not program the remote control functions of equipment other than AVV components, such as air conditioners, etc.

■ To check the programmed contents

1 Set to the USE position.



2 Set the mode.

- Set to the mode used with the key to be checked.

3 Press the key to be checked.

- Verify that the component to be operated works correctly.

■ To change the programmed contents

Perform the programming operation again referring to "Programming operation" on the previous page.

- The previously-programmed content is cleared automatically and replaced by the newly-programmed content.

■ To clear the entire programmed contents

You can clear all of the programmed contents, returning this unit to the initial status.

1 Set to the LEARN position.



2 Remove the battery case cover.



3 Press any one of the "learning" keys.

- The LEARN indicator lights up.

4 Press the RESET key.

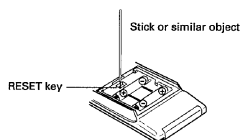

- The RESET key must be pressed within 30 seconds of pressing one of the learning keys.

Specifications (For U.S.A. and Canada)

⚠ **Caution:** Read this page carefully to ensure safe operation.

Rated power output

120 watts per channel minimum RMS, both channels driven, at 8 Ω from 20,000 Hz with no more than 0.06% total harmonic distortion. (FTC)

Total harmonic distortion LINE input to SPEAKER output

20Hz to 20,000 Hz 0.06% at rated power into 8 Ω

In case of difficulty

What appears to be a malfunction may not always be serious. If your unit should not perform as expected, consult the table below to see if the problem can be corrected before seeking help from your dealer or service representative.

Amplifier, speakers

Symptom	Cause	Remedy
Sound is not output.	<ul style="list-style-type: none"> The speaker cords are disconnected. Speakers switched off. The volume is set to the minimum position. The muting function of the amplifier is set to ON and the point indicator is blinking. The audio cords are disconnected. 	<ul style="list-style-type: none"> Connect them properly referring to "System connections". Check speaker switch. Adjust the volume to a proper level. Press the MUTING key on the front panel or MUTE key on the remote control unit to OFF. Connect them properly.
No sound comes out, and "-----" is blinking on the display.	<ul style="list-style-type: none"> Speaker cords are short-circuited. 	<ul style="list-style-type: none"> Turn the power off, eliminate the short circuiting, then turn on the power again.
Sound is not output from one of the speakers.	<ul style="list-style-type: none"> The speaker cord is disconnected. The BALANCE control is set to an extreme position. 	<ul style="list-style-type: none"> Connect it properly referring to "System connections". Adjust the Left/Right balance.
A hum noise is generated when the PHONO input selector key is pressed.	<ul style="list-style-type: none"> The audio cord from the turntable is not inserted securely into the PHONO jacks. The turntable is not grounded. 	<ul style="list-style-type: none"> Insert the audio cord plugs securely into the PHONO jacks. Connect the grounding wire to the GND terminal on the rear panel.

Remote control unit

Symptom	Cause	Remedy
Remote control operation is not possible.	<ul style="list-style-type: none"> Batteries are exhausted. The audio cords and the system control cords are not connected properly. The remote control unit is too far away from the main system, controlling angle is too large, or there is an obstacle in between. The source component to be operated does not contain the analog disc, tape(s) or CD. An attempt is made to play a tape which is being recorded in the cassette deck. The LEARN/USE switch is set to LEARN (RC-160 only). 	<ul style="list-style-type: none"> Replace with new batteries. Connect properly referring to "System connections". Operate the remote control unit within the controllable range. Place an analog disc, tape(s) or CD in the source component to be played. Wait until the recording is completed. Set the LEARN /USE switch to USE.

Notes:

- This system is microprocessor-controlled, so malfunction may occur due to external noise or interference noise. In such a case, unplug the power cord, plug it and turn power on again.
- Do not use contact cleaners because it could cause a malfunction. Be specially careful against contact cleaners containing oil, for they may deform the plastic components.

Specifications (For U.S.A. and Canada)

 **Caution:** Read this page carefully to ensure safe operation.

Rated power output

120 watts per channel minimum RMS, both channels driven, at 8 Ω from 20,000 Hz with no more than 0.06% total harmonic distortion. (FTC)

Total harmonic distortion LINE input to SPEAKER output	
20Hz to 20,000 Hz	0.06% at rated power into 8 Ω
Frequency response	10 Hz to 90 kHz, 0 dB, -3 dB
Input sensitivity/impedance	
PHONO	2.5 mV/47 k Ω
TUNER/TAPE/CD/VIDEO	200 mV/47 k Ω
TAPE 2/ADAPTOR	200 mV/47 k Ω
Signal-to noise ratio (IHF-A)	
PHONO	73 dB for 2.5 mV input
TUNER/TAPE/CD/VIDEO	102 dB
Phono maximum input level	100 mV, T.H.D. 0.5% at 1 kHz
Output level/impedance	
Tape REC (Pin)	200 mV/3.3 k Ω
Phono frequency response	RIAA standard curve ± 0.3 dB (20 Hz to 20,000 Hz)
Loudness control (with flat graphic equalizer curve)	+5 dB at 100 Hz +3 dB at 10 kHz
Graphic equalizer control	
(60 Hz, 150 Hz, 400 Hz, 1 kHz, 2.4 kHz, 6 kHz, 15 kHz)	± 12 dB

General

Power consumption	2.8 A
AC outlets	
SWITCHED	3; (Total 150 W, 1.25 A max.)
Dimensions	
	W: 440 mm (17-5/16")
	H: 132 mm (5-3/16")
	D: 331 mm (13-1/16")
Weight (Net)	10.0 kg (22.0 lb)

Note:
KENWOOD follows a policy of continuous advancements in development. For this reason specifications may be change without notice.

For CANADA DOC REGULATION

"This digital apparatus does not exceed the CLASS B limits for radio noise emissions from digital apparatus as set out in the radio interference regulations of the Canadian Department of Communications."

For the U. S. A.

FCC WARNING:

This equipment may generate or use radio frequency energy. Changes or modifications to this equipment may cause harmful interference unless the modifications are expressly approved in the instruction manual. The user could lose the authority to operate this equipment if an unauthorized change or modification is made.

NOTE:

This equipment has been tested and found to comply with the limits for a Class B digital device, pursuant to Part 15 of the FCC Rules. These limits are designed to provide reasonable protection against harmful interference in a residential installation. This equipment may cause harmful interference to radio communications, if it is not installed and used in accordance with the instructions. However, there is no guarantee that interference will not occur in a particular installation. If this equipment does cause harmful interference to radio or television reception, which can be determined by tuning the equipment off and on, the user is encouraged to try to correct the interference by one or more of the following measures:

- Reorient or relocate the receiving antenna.
- Increase the separation between the equipment and receiver.
- Connect the equipment into an outlet on a circuit different from that to which the receiver is connected.
- Consult the dealer or an experienced radio/TV technician for help.

Specifications (For other countries)

 **Caution: Read this page carefully to ensure safe operation.**

Maximum continuous power output (IHF '66) From 20 Hz to 20 kHz, 0.06% T.H.D. at 8Ω	125 W + 125W
EIAJ power at 8Ω	170 W + 170 W
Total harmonic distortion LINE input to SPEAKER output 1 kHz	0.06% at rated power into 8Ω
Frequency response	10 Hz to 90 kHz, 0 dB, -3 dB
Input sensitivity/impedance	
PHONO	2.5 mV/47 kΩ
TUNER/TAPE/CD/VIDEO	200 mV/47 kΩ
TAPE 2/ADAPTOR	200 mV/47 kΩ
Signal-to noise ratio (IHF-A)	
PHONO	73 dB for 2.5 mV input
TUNER/TAPE/CD/VIDEO	102 dB
Phono maximum input level	100 mV, T.H.D. 0.5% at 1 kHz
Output level/impedance	
Tape REC (Pin)	200 mV/3.3 kΩ
Phono frequency response	RIAA standard curve ± 0.3 dB (20 Hz to 20,000 Hz)
Loudness control (with flat graphic equalizer curve)	+5 dB at 100 Hz +3 dB at 10 kHz
Graphic equalizer control (60 Hz, 150 Hz, 400 Hz, 1 kHz, 2.4 kHz, 6 kHz, 15 kHz)	± 12 dB

General

Power consumption	250 W
AC outlets	
SWITCHED	For Australia: 2; (Total 200 W max.) For other countries: 3; (Total 200 W max.)
Dimensions	W: 440 mm H: 132 mm D: 331 mm
Weight (Net)	10.0 kg

Note:
KENWOOD follows a policy of continuous advancements in development. For this reason specifications may be change without notice.

KENWOOD